

Features

- Epitaxial Planar Die Construction
- Complementary NPN Type Available (DCX68)
- Ideally Suited for Automated Assembly Processes
- Ideal for Medium Power Switching or Amplification Applications
- **Lead Free By Design/RoHS Compliant (Note 1)**
- **"Green" Device (Note 2)**

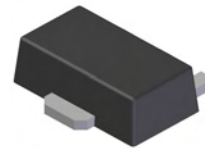

SOT89-3L

Mechanical Data

- Case: SOT89-3L
- Case Material: Molded Plastic, "Green" Molding Compound. UL Flammability Classification Rating 94V-0
- Moisture Sensitivity: Level 1 per J-STD-020D
- Terminals: Finish — Matte Tin annealed over Copper leadframe (Lead Free Plating). Solderable per MIL-STD-202, Method 208
- Marking Information: See Page 3
- Ordering Information: See Page 3
- Weight: 0.072 grams (approximate)

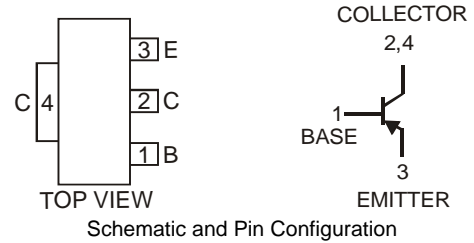

Maximum Ratings @ $T_A = 25^\circ\text{C}$ unless otherwise specified

Characteristic	Symbol	Value	Unit
Collector-Base Voltage	V_{CBO}	-25	V
Collector-Emitter Voltage	V_{CEO}	-20	V
Emitter-Base Voltage	V_{EBO}	-5.0	V
Collector Current	I_C	-1.0	A
Peak Pulse Power	I_{CM}	-2.0	A

Thermal Characteristics

Characteristic	Symbol	Value	Unit
Power Dissipation (Note 3) @ $T_A = 25^\circ\text{C}$	P_D	1	W
Thermal Resistance, Junction to Ambient Air @ $T_A = 25^\circ\text{C}$ (Note 3)	$R_{\theta JA}$	125	$^\circ\text{C/W}$
Operating and Storage Temperature Range	T_J, T_{STG}	-55 to +150	$^\circ\text{C}$

Electrical Characteristics @ $T_A = 25^\circ\text{C}$ unless otherwise specified

Characteristic	Symbol	Min	Typ	Max	Unit	Test Conditions	
OFF CHARACTERISTICS (Note 4)							
Collector-Base Breakdown Voltage	$V_{(BR)CBO}$	-25	—	—	V	$I_C = -10\mu\text{A}, I_E = 0$	
Collector-Emitter Breakdown Voltage	$V_{(BR)CEO}$	-20	—	—	V	$I_C = -1\text{mA}, I_B = 0$	
Emitter-Base Breakdown Voltage	$V_{(BR)EBO}$	-5.0	—	—	V	$I_E = -10\mu\text{A}, I_C = 0$	
Collector-Base Cutoff Current	I_{CBO}	—	—	-100 -10	nA μA	$V_{CB} = -25\text{V}, I_E = 0$ $V_{CB} = -25\text{V}, I_E = 0, T_A = 150^\circ\text{C}$	
Emitter-Base Cutoff Current	I_{EBO}	—	—	-100	nA	$V_{EB} = -5.0\text{V}, I_C = 0$	
ON CHARACTERISTICS (Note 4)							
DC Current Gain	DCX69, DCX69-16, DCX69-25	h_{FE}	50	—	—	—	$V_{CE} = -10\text{V}, I_C = -5.0\text{mA}$
			60	—	—	—	$V_{CE} = -1.0\text{V}, I_C = -1.0\text{A}$
			85	—	375	—	$V_{CE} = -1.0\text{V}, I_C = -500\text{mA}$
			100	—	250	—	$V_{CE} = -1.0\text{V}, I_C = -500\text{mA}$
Collector-Base Cutoff Current	DCX69-16	h_{FE}	160	—	375	—	$V_{CE} = -1.0\text{V}, I_C = -500\text{mA}$
			DCX69-25	—	—	—	—
Collector-Emitter Saturation Voltage	$V_{CE(SAT)}$	—	—	-0.5	V	$I_C = -1.0\text{A}, I_B = -100\text{mA}$	
Base-Emitter Turn-On Voltage	$V_{BE(ON)}$	—	—	-0.7 -1.0	V	$V_{CE} = -10\text{V}, I_C = -5\text{mA}$ $V_{CE} = -1.0\text{V}, I_C = -500\text{mA}$	
SMALL SIGNAL CHARACTERISTICS							
Current Gain-Bandwidth Product	f_T	40	200	—	MHz	$V_{CE} = -5.0\text{V}, I_C = -50\text{mA}, f = 100\text{MHz}$	
Output Capacitance	C_{obo}	—	17	—	pF	$V_{CB} = -10\text{V}, f = 1\text{MHz}$	

- Notes:
1. No purposefully added lead.
 2. Diodes Inc.'s "Green" policy can be found on our website at http://www.diodes.com/products/lead_free/index.php.
 3. Device mounted on FR-4 PCB; pad layout as shown on page 4 or in Diodes Inc. suggested pad layout document AP02001, which can be found on our website at <http://www.diodes.com/datasheets/ap02001.pdf>.
 4. Measured under pulsed conditions. Pulse width = 300 μs . Duty cycle $\leq 2\%$.

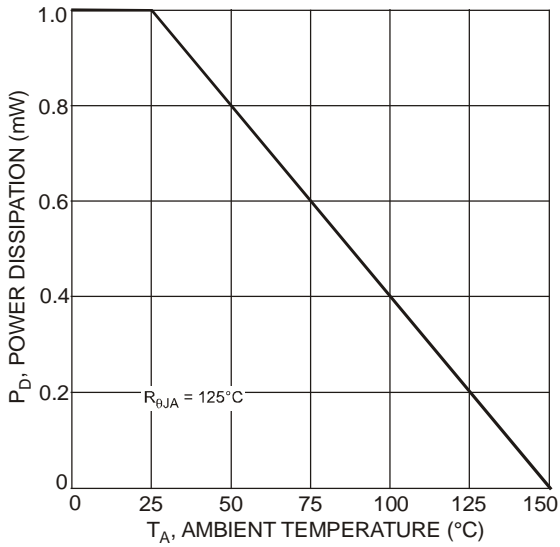

Fig. 1 Power Dissipation vs. Ambient Temperature (Note 3)

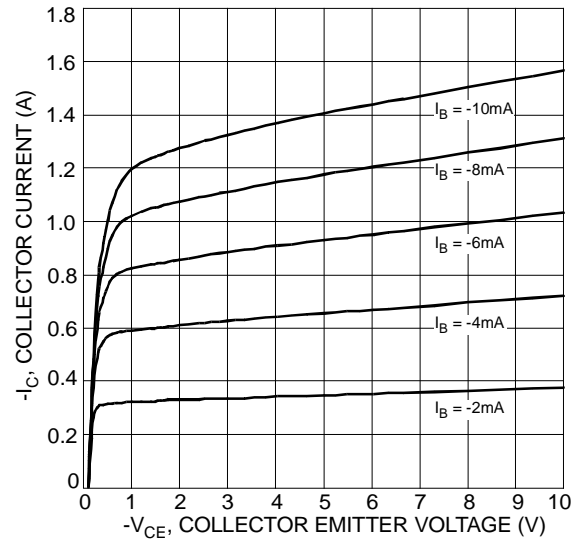

Fig. 2 Typical Collector Current vs. Collector-Emitter Voltage

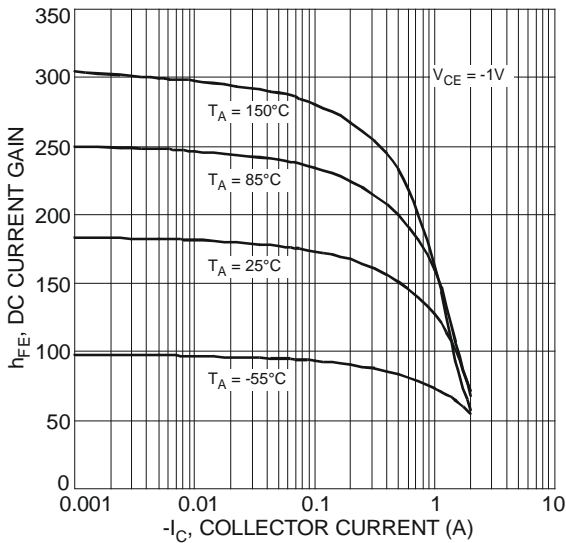

Fig. 3 Typical DC Current Gain vs. Collector Current (DCX69-16)

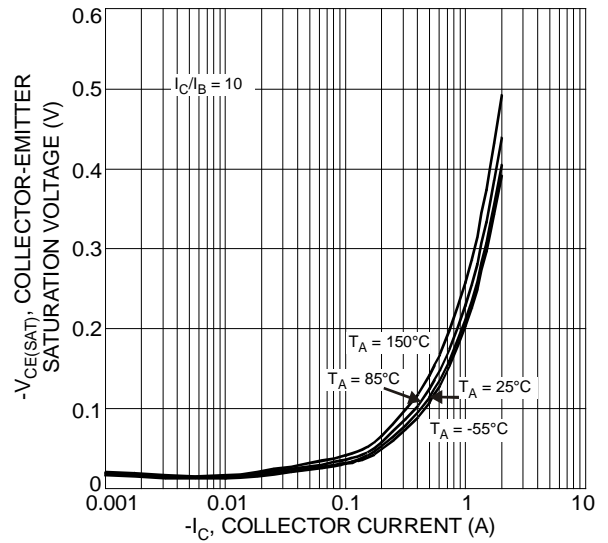

Fig. 4 Typical Collector-Emitter Saturation Voltage vs. Collector Current

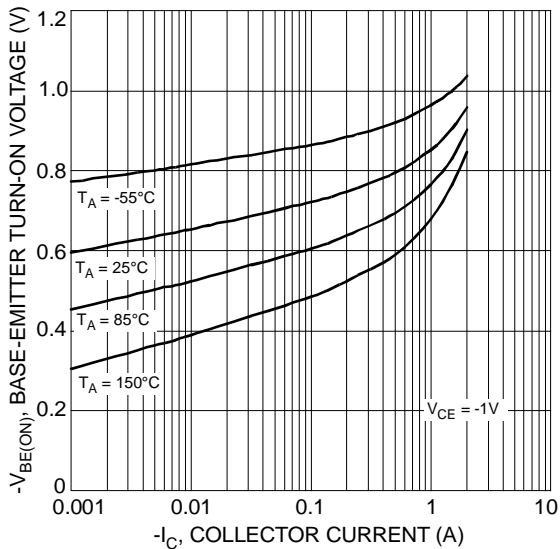

Fig. 5 Typical Base-Emitter Turn-On Voltage vs. Collector Current

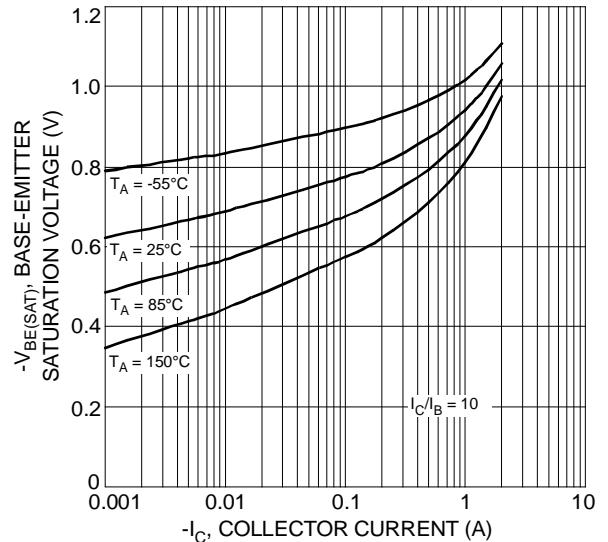

Fig. 6 Typical Base-Emitter Saturation Voltage vs. Collector Current

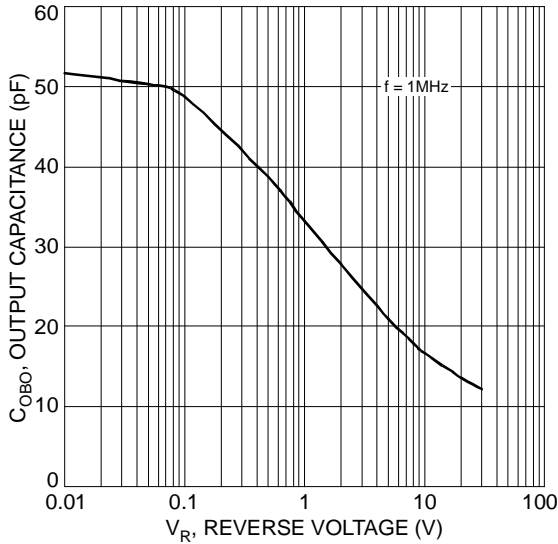

Fig. 7 Typical Output Capacitance Characteristics

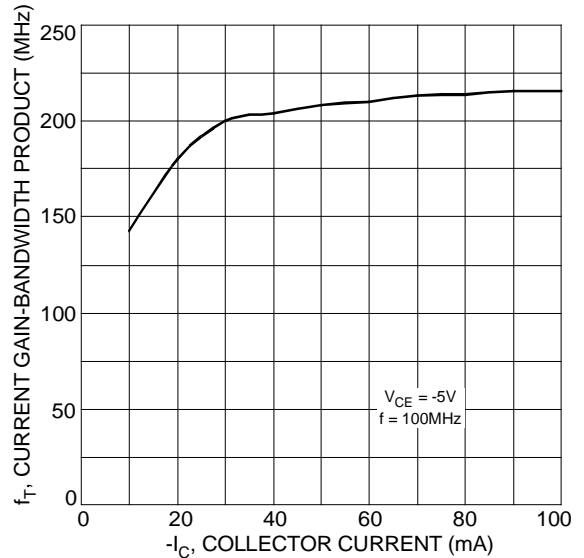

Fig. 8 Typical Gain-Bandwidth Product vs. Collector Current

Ordering Information (Note 5)

Device	Packaging	Shipping
DCX69-13	SOT89-3L	2500/Tape & Reel
DCX69-16-13	SOT89-3L	2500/Tape & Reel
DCX69-25-13	SOT89-3L	2500/Tape & Reel

Notes: 5. For packaging details, go to our website at <http://www.diodes.com/ap02007.pdf>.

Marking Information

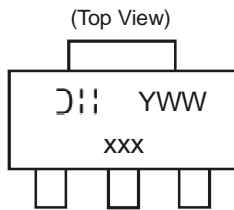

xxx = Product Type Marking Code:
 P12 = DCX69
 P12-16 = DCX69-16
 P12-25 = DCX69-25
 YWW = Date Code Marking
 Y = Last digit of year ex: 7 = 2007
 WW = Week code 01 - 52

Package Outline Dimensions

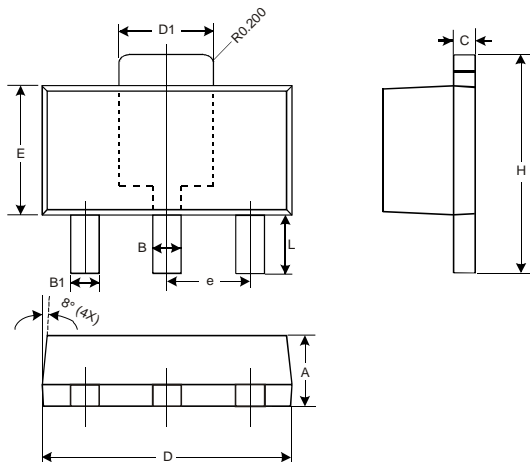

SOT89-3L			
Dim	Min	Max	Typ
A	1.40	1.60	1.50
B	0.45	0.55	0.50
B1	0.37	0.47	0.42
C	0.35	0.43	0.38
D	4.40	4.60	4.50
D1	1.50	1.70	1.60
E	2.40	2.60	2.50
e	—	—	1.50
H	3.95	4.25	4.10
L	0.90	1.20	1.05
All Dimensions in mm			

Suggested Pad Layout

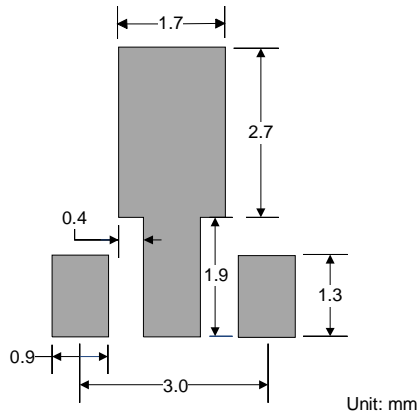

IMPORTANT NOTICE

Diodes Incorporated and its subsidiaries reserve the right to make modifications, enhancements, improvements, corrections or other changes without further notice to any product herein. Diodes Incorporated does not assume any liability arising out of the application or use of any product described herein; neither does it convey any license under its patent rights, nor the rights of others. The user of products in such applications shall assume all risks of such use and will agree to hold Diodes Incorporated and all the companies whose products are represented on our website, harmless against all damages.

LIFE SUPPORT

Diodes Incorporated products are not authorized for use as critical components in life support devices or systems without the expressed written approval of the President of Diodes Incorporated.